

Article number: 201018027

Description: E+G Collar clamp GN 873-28

## Measures

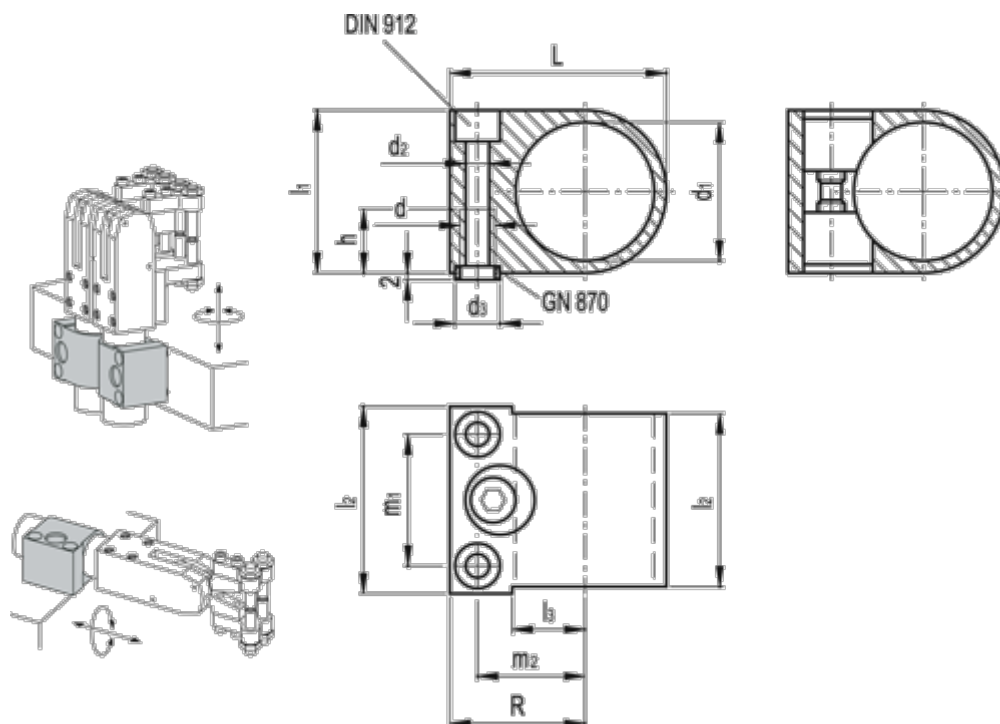

d	= M8	l3	= 36
d1	= 28	l4	= 16
d2	= 6.5	m1	= 26
d3 H8/h6	= 11	m2	= 28.5
h	= 14.0	R	= 35
L	= 52.0	Weight (g)	= 230
l1	= 34		
l2	= 39		